

creative since 1965
the modular icon by
Fritz Haller & Paul Schärer



73 inspirations for
future-proof work environments

WORK



Price list
Scan the QR code
to view the price list.

Welcome

- 4 Receptions
- 12 Lobbies and waiting areas

Focus

- 14 Individual workstations
- 26 Remote work

Collaborate

- 32 Team workstations
- 38 Meetings
- 48 Lounges and relaxation

Organize

- 54 Shelving
- 60 Lockers
- 62 Technical zones

Adaptive environments

- 66 USM Haller – to grow with you

Wireless electification

- 68 USM Haller E – for light and charging

Smart desks

- 70 USM Haller – highly customizable
- 72 USM Kitos – ergonomic and energy saving

64 What's unique about USM

- 74 USM and sustainability
- 76 Product information
- 86 Colors & surfaces

Creating multifunctional spaces sounds so simple but may be a true challenge in times of permanent change. Responding to this with creativity has always been a key strength of USM. For almost 60 years, we have celebrated modularity and fluidity – the ability to adapt to evolving needs at any time; the ability to provide agile yet longlasting solutions for multifunctional, hybrid spaces.

The office as a place to gather for creative exchange and interdisciplinary cooperation will continue to be of central importance in the future. Let's shape it together:

Let's make your office a place that promotes creativity, collaboration and evolves with your company! A place people like to be in! A place that celebrates your organization's culture and values!

USM Haller is the epitome of timeless design: almost 60 years ago, Fritz Haller and Paul Schärer created a completely new aesthetic – a furniture system inspired by architecture.

Two visionaries, one idea

After completing his engineer studies, Paul Schärer Jr. joined the family business in 1961. The engineer had big ideas: he wanted to build a modern, industrial factory. He partnered with Fritz Haller, a respected architect of Solothurn school.

Born from architecture

Haller developed a flexible construction system with various steel modules. This inspired Paul Schärer Jr., who had a bigger vision: interior design that complements architecture. Together, they developed a modular piece of furniture that was predestined for further development.

Furniture with a system

The centerpiece of the system is a chrome-plated ball with six threaded holes. It connects the chrome-plated steel tubes in any combination. Finally, add sheet steel panels, which are powder-coated in various colors. Everything was intended for the company's own offices.

From prototype to USM Haller

When photos of the forward-thinking furniture system with its innovative aesthetics appeared in architecture journals, it was hailed an international sensation. A commission came from the Rothschild bank in Paris consisting of 600 workstations – the company's first major project. Series production began in 1969.

Less is more

With endless possibilities, the USM Haller system can be configured at will and adjusted to changing requirements, in all directions. Its strikingly fascinating minimalism is eye-catching and inspiring for everyone who values design, quality and functionality.

Modern art

An icon of modern design, USM Haller has been on display at the MoMA in New York since 2001 and recognized as a 'work of applied art' since 1988. USM Haller continues to evolve, while remaining true to itself by retaining original characteristics and invites users to challenge their own creativity.

From Münsingen out into the world

Alexander Schärer has headed up this fourth-generation family business since 2000. Production is still carried out at the headquarters in Münsingen. USM employs 450 people and currently has subsidiaries in the USA, France, Germany, UK, Japan and China. USM products are distributed by dealers in over 40 countries. Sustainability has always been a top priority. In 2008, USM was awarded Greenguard environmental certification and received the Cradle-to-Cradle® environmental label in 2018. The vision is to become a fully circular company by 2030. → S. 74

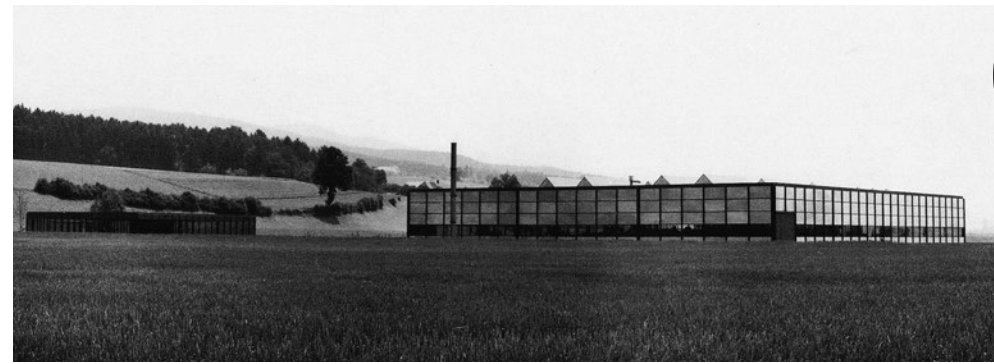

- 1 New factory (1963) and office pavilion (1965) in Münsingen, designed by Fritz Haller.
- 2 In 1965, USM Haller was developed to furnish personal use workspaces within visionary architecture.
- 3 Schärer family home (1969), designed by Fritz Haller, furnished with USM Haller.
- 4 The key to space. Balls, tubes, panels: what began 60 years ago continues to inspire today.

the modular icon by
Fritz Haller & Paul Schärer,
Switzerland

f. haller paul schärer

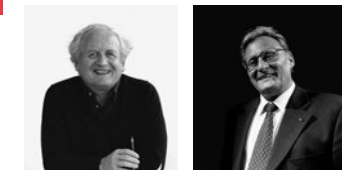

Welcome

1 A warm arrival

This reception in ruby red sends out a clear signal as a place to meet in the open space. Lush worlds of plants serve as semi-transparent zoning and the waiting area invites you to linger.



Welcome

Customize your centre piece!

A reception has a key role to play: it is the linchpin of an organization: a place to welcome guests that ensures the right first impression. Often free-standing, the statement piece represents the stability and integrity of the company organization offering a hospitable waiting area. A USM reception desk is just as individual as a bespoke piece, but it is much more adaptable. The front and back can easily adapt to changing needs such as the integration of a showcase, storage display, protection screens and a USB docking station.



↳
2 **Multifunctional work center**
This design incorporates a double workstation and high-quality reception in one. Storage compartments are accessible from both sides, so users can access everything they need quickly.

→
3 **A clean appearance**
Sleek from the front, multi-functional from the back, the glass perfectly showcases beautiful items. Customize your reception for added organisation with elements such as doors, drawers and organizational accessories.

↓
4 **Simplify interactions**
The reception desk is the essential point of contact for visitors. This fully functional design includes a storage for personal belongings or office supplies.

↓
5 **Guest seating**
Combine a long work table with an angled counter to create space for comfortable interactions with your guests.

↓
6 **Barrier-free**
Customize desks with the USM Haller system to allow space for guests, including ADA compliant solutions.



7 360° of functionality and design

A USM Reception doesn't have a front or a back – it is aesthetically pleasing from all sides. It is ideal for brand new spaces and can easily be part of a retrofit to meet changing safety standards. A variety of USM product offers a wide range of protection measures.



Welcome



↙
8 **Purity**
The reception provides a clutter-free blank canvas which gives a professional first impression for corporate environments.

↓
9 **Bring the green inside**
Add a touch of plants to meeting rooms and reception areas to create a healthy and calm oasis indoors.



Welcome

Create seamlessly-designed welcome areas!

USM Modular Furniture is designed to create multi-functional and transitional spaces that no longer have to comply with established room partitions. Express your very own corporate culture by designing a completely customized lobby to create a lasting first impression.

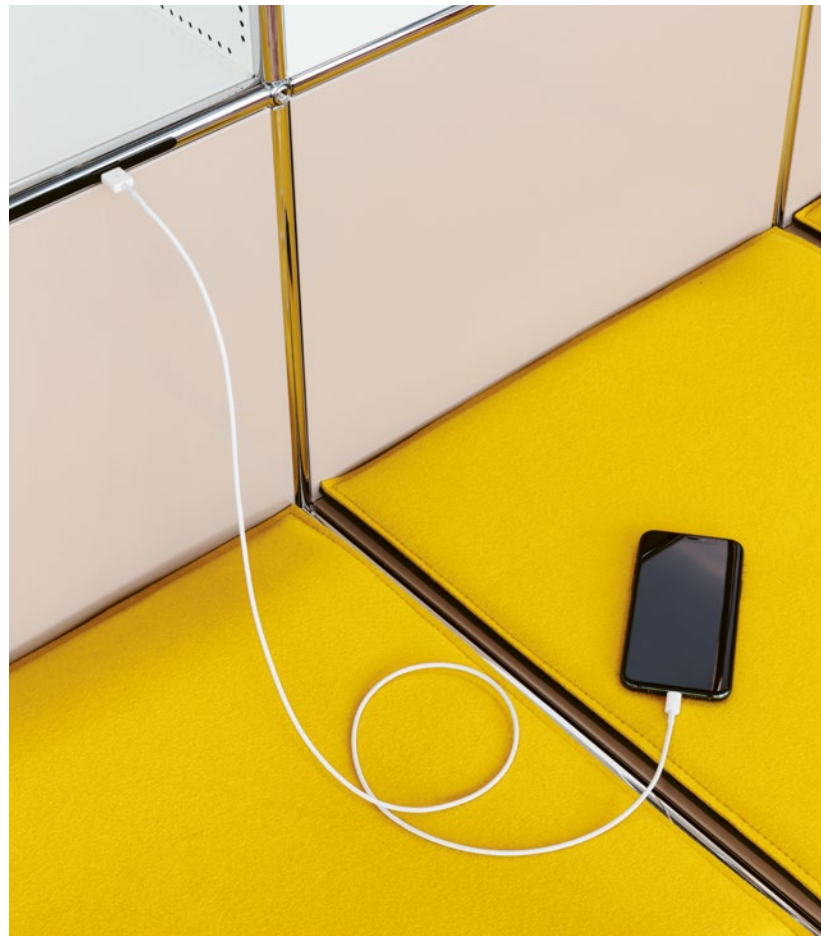

- ←
10 **Recharge**
Being able to charge your devices is a much-needed part of working life. The USB charger integrated into the furniture is on hand to help.
- 11 **Multipurpose sculpture**
USM can be used as a spatial divider as well as an eye-catching addition to waiting areas, providing the perfect place for informal get-togethers.
- ↓
12 **All in one**
Plants create a pleasant atmosphere and there is also space for plants, storage and display magazines.
- ↓
13 **Welcome screen**
More than just shelving, this design creates a sense of place in your entrance area. This semi-transparent room divider, which can be used from either side, is the ideal backdrop for your lounge area, with a built-in TV screen.



12



13



FOCUS

14 Expressive

This design offers high shelves, low showcases and large-format tables in elegant materials: USM Modular Furniture represents a fully flexible solution to meet your needs.



Focus



↙
15 **Sit stand solution**
The USM Kitos table is manually height adjustable. Its elegant black linoleum contrasts beautifully with splashes of color.

↓
16 **Connectivity**
Added value: The adaptation points in the tabletop allow for easy insertion of accessories such as desk lamps and USBs and provide access for cables underneath the slidable table surface.

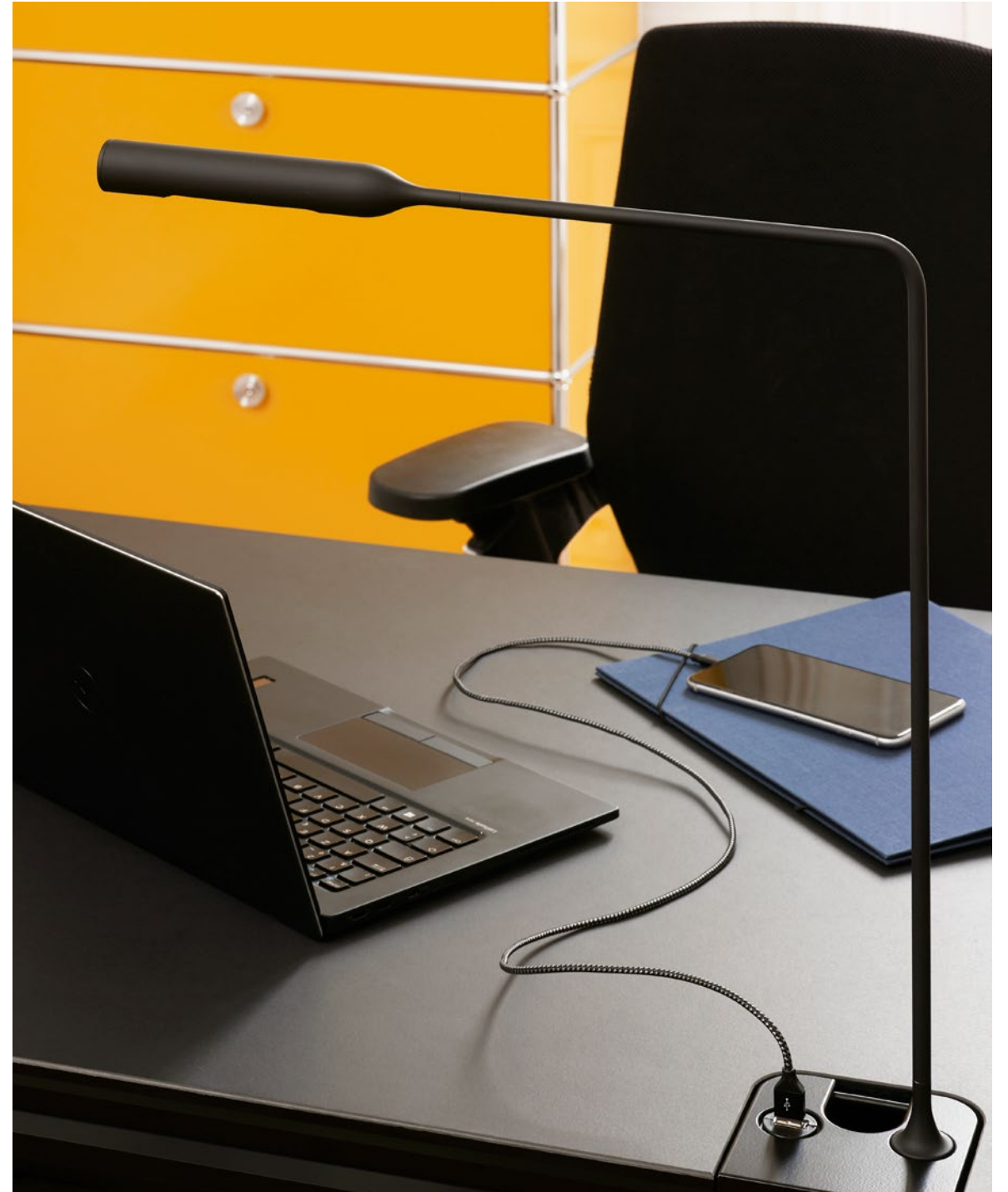

17 Maximum Efficiency

We call it a z-configuration. A shared storage unit with drawers is accessible from both sides, connecting two individual workstations to one surface.

Lock securely, share easily

The storage units can be locked securely, ensuring confidential documents remain private. With the introduction of the new Lock C and its easy management via the USM app you can easily enable third parties to receive access – perfect for when you plan to work remotely.

Focus

Be mindful that needs may change over time
USM grows with its owner: When starting a business, what more do you need than a desk and minimal storage? Over time the business and size of your team may grow. Add functions step by step and let the furnishings align to your business' changing needs.

18 Tear down the walls
Who needs walls when you can design spaces so perfectly that they can seamlessly be used for multiple functions at the same time? The gentian blue central unit is a multimedia library and facilitates collaboration.

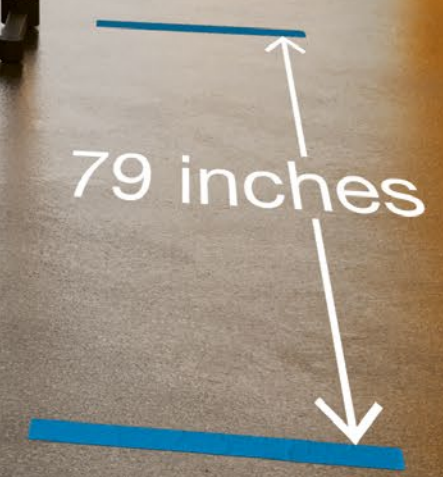

Focus

Provide space, create privacy!

Longer tables guarantee comfortable distances between coworkers. In addition, privacy panels or transparent screens can easily be put up or dismantled in no time at all. Fenix table surfaces are particularly resistant to scratches and fingerprints and are able to withstand regular cleaning.



Versatility

The two adaptation points in the tabletop allow for easy insertion of up to four accessories, or holders for protection screens, making it possible to configure the table to meet individual user requirements.

21



22



←
19 **Protection screens**
Adaptation points located on the table surfaces enable a wide range of applications. For example, they allow the immediate installation of protective glass.

→
20 **Benches with end of desk storage**
Extra-long USM Haller tables combined with USM Privacy Panels create modern team workstations. End of desk storage in a ruby red shade provides space for personal belongings and adds a pop of color.

↓
21 **Agility**
Work methods may vary, teams change size and structure. The office layout must adapt to evolving needs and projects. USM Haller Privacy Panels can support changing office layouts by dividing up the space fairly.

↓
22 **Usable from all sides**
One table – two workstations. At the impressive 118" long USM Haller table, plants and USM Privacy Panels can create a sense of privacy without separating employees from their co-workers too much.



23 Hot desking

Employees can choose a free workstation at the long worktable. Computer monitors are mounted in the adaptation points of the USM Haller tables. Simply connect yourself up and off you go.



Focus

Empower your employees to work at home!

Being able to offer a workplace at home is an important argument for attracting top talents nowadays. The advantage of USM: the solutions harmonize with every style of living and available space; as a dedicated workplace with an ergonomically height-adjustable table or as a multi-functional design classic that blends unobtrusively into the living environment.



↙
24 **Powerless height adjustability**
A whole new working experience in seconds and with minimal effort, the Kitos Table M can easily be adjusted from a sitting position to a standing one.

→
25 **Ergonomic**
A solution for the sophisticated office: the impressively large 70" x 35" table can be height-adjusted manually using just one hand. Its tabletop in a brown oiled oak veneer paired with a playful sideboard creates a homely atmosphere.

↓
26 **Free standing and versatile**
The round, free standing USM Kitos E tables encourage active and varied use. They can be quickly adjusted in height without the need for power or electricity, making for the perfect standing workstation as well as a comfortable breakfast table.

↓
27 **Matchmaking**
The Haller modular furniture system can be matched to the dimensions of the USM Kitos tables. And no space is ever wasted: storage space can be accessed from any side.



26



27



28 Creative repurposing
A table does not necessarily need four legs. Take advantage of the creative potential of repurposing: two timeless sideboards using USM's craftsmanship make a perfect desk in a league of its own, with the ideal sitting height easily achievable.





↙
29 Niche player
 Elegant and colorful, a home office can be integrated into even the smallest residential space. The extra narrow, 49" x 30" USM Haller table with black linoleum worksurface doesn't require much room and offers a space-efficient working set up.

→
30 A classic with multiple benefits
 A home office that's barely visible: in the blink of an eye, this stylish sideboard is transformed into a workstation. Pull back the extension shelf, put the laptop away, and your work is done for the day.

↓
31 Space miracle
 A compact office in a small space: shelves and pull-outs accommodate all the things needed during a workday. Even a printer can be housed discreetly.

↓
32 Command centre
 Keep everything under control while working from home. Two workstations integrate into a beautiful multifunctional shelf offering generous space for working and a place to put your personal belongings.



Collaborate



33 Connecting people
Today's workplace gives its users the choice of where and how they want to work. An office space needs to support different ways of working with the ability to come together or meet in a more confidential setting. Large USM Haller tables offer employees greater freedom in how they meet. Privacy Panels* allow for quiet spaces and USM Haller creates a central gathering point.

*Standing room dividers are not available in North America.

Collaborate

Encourage collaboration!

Opportunities for spontaneous interactions are essential in the modern-day workplace. From a meeting area and a cafeteria to a library and a brainstorming area USM can provide solutions where employees are inspired, visitors feel welcome and colleagues are at ease.



↙
34 **Landscaped offices**
USM Kitos desks provide a flexible office solution for a team of colleagues. The system enables working individually and as part of a group where necessary. Manual height adjustment allows for hassle-free Sit to Stand working.

→
35 **One team, one table**
Get together at one large desk. USM Haller has 118" long desks creating work islands in a flexible workspace. The set up includes power points for various smart accessories such as lamps, USBs and protection screens, as well as grommet hatches for immediate network access.

↓
36 **Get together**
Two extra-large USM Haller tables are great for spontaneous discussions, meetings or presentations. Everyone simply brings their own caddy, containing the desk accessories, paperwork and other personal belongings necessary for the job.

↓
37 **Office forum**
Create your own office forum, a spot where you take a break or conduct an informal meeting, with built-in storage for whatever the team might need.



36



37



Collaborate

Alter the space with your own ideas!

Free standing USM Privacy Panels* are ideal for creating quieter zones within open plan spaces. Different areas can exist within one space seamlessly, including meeting zones, relaxation areas, a phonebooth, technical zones and storage areas. Each area can be customized by size, height, shape and color to suit specific functions and needs. Plus, everything can be re-configured at any time!



↙
38 **Fluid room concepts**
Open structures are easily divided with USM Privacy Panels* to enable spontaneous meetings without disturbing others in their work. These can be deconstructed at any time. This allows the space to continue to be used flexibly and collaboration is facilitated.

→
39 **Optimized acoustics**
USM Privacy Panels* have been proven to improve room acoustics, which adds value when dividing open plan spaces into different zones.

↓
40 **Creative village**
USM Privacy Panels* offer a modular and flexible way to create breakout areas within a room to enable different types of work to happen in a small space. Add a touch of color where appropriate.

* Standing room dividers are not available in North America.



41 Meeting, presenting,
teamwork

The Kitos M Meeting extra-sized table with manual height adjustment provides the ideal meeting setting. A media unit holds all the technology.



Collaborate

Provide supersized, height-adjustable tables!

The Kitos M Meeting is the first mechanically height-adjustable meeting table that is both supersized and extra stable. A tension spring mechanism, which lasts much longer than a gas pressure spring, adjusts quickly and easily. Optional grommet hatches on both sides give easy access to power.



↳
42 **Supersized table**
Enjoy a generously proportioned table at a comfortable height. The USM Kitos M Meeting desk is made for ad-hoc standing meetings of up to eight people and is easily manually height adjustable.

→
43 **Multipurpose**
Creating inspiring spaces that foster innovation contributes to establishing a dynamic corporate culture. The meeting area can host video calls, presentations, strategy meetings and even serve as a place to meet with colleagues for a coffee break.

↓
44 **Ad-hoc get together**
Stand and chat in an informal, spontaneous way over a coffee with the USM Kitos M meeting desk. Plug into the network through two grommet hatches.

↓
45 **Bring your own device**
Personal desk accessories and relevant documents for group projects can easily be stored in the dedicated caddy. When the work is done, the caddy can simply be placed back on the shelf. The extra-large, 98" x 39" table provides space for larger meetings.



Collaborate

Think dynamic meeting spaces!

Make your meetings more dynamic. Instead of one large conference table, we recommend a number of smaller tables instead. These can be quickly re-arranged to create exactly the right configuration for every occasion. Use the system as individual tables for group work with plenty of space in between. Furniture on castors provides a fully mobile solution.

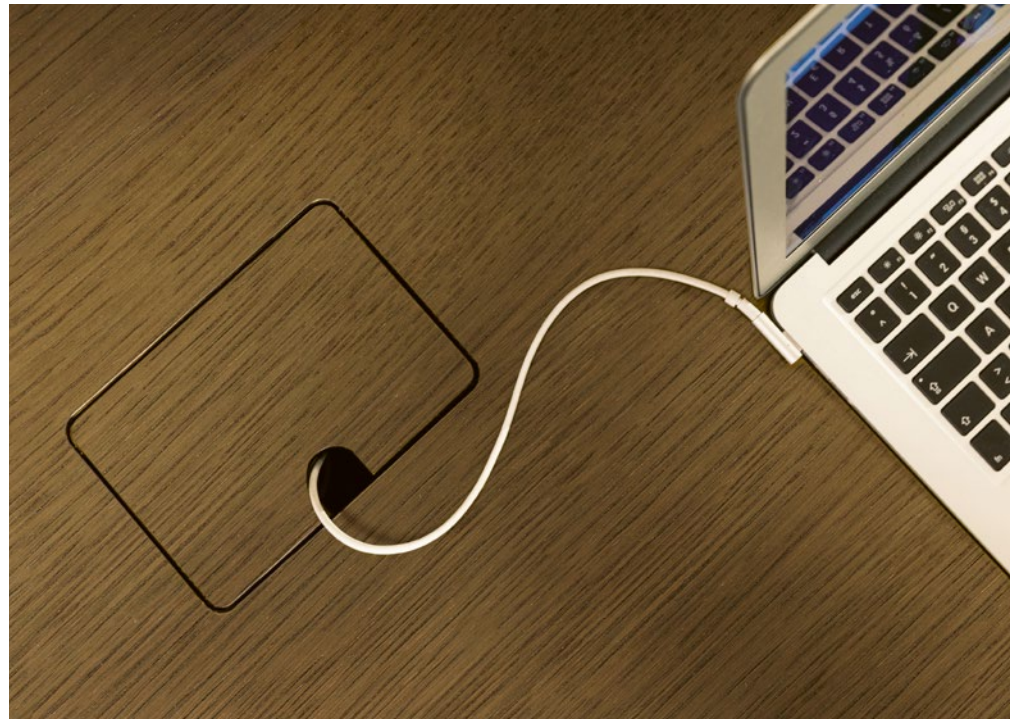

↙
46 **Connectivity**
Discreet table grommet hatch allow meeting participants to connect to power and networks at any time.

→
47 **Rearrange!**
Create your versatile, flexible meeting room: all elements can be quickly reconfigured according to what is required.

↓
48 **One group, one table**
Meet in the most stylish way possible: the 120" long USM Haller table can host up to 8 people.

↘
49 **Presentations in front!**
The screen is often the centre of attention in meetings. Rearrange a group of tables around the screen when required and then a sideboard discreetly hides all the technology when not in use.



Sound absorption
Perforated metal panels with a fleece-covered interior: acoustic USM Haller elements significantly reduce background noise, thus improving the overall work environment.



Collaborate

50 Multimedia multi-use
Frame all technical equipment
with an eye-catching shelf.
Small individual tables can
be moved within the space
to provide social distancing
or for different meeting
configurations.



Collaborate

Incorporate cosy corners!

The greater the variety of places to meet, the more use they will get. Take advantage of the flexibility of USM by creating spaces within spaces to provide areas for collaboration and concentrated work. USM's wide variety of colors, Worlds of Plants concept, and cable-free integration of warm light creates a truly inviting atmosphere in a workplace setting.



- ↙ 51 **Focus corner**
USM Haller can also create spaces for focussed work or confidential conversations and thanks to the perforated panels, the acoustics are perfect.
- 52 **Smaller, focussed areas**
Smaller format tables can easily be integrated into the office landscape, creating useful spots to meet and communicate in.
- ↓ 53 **Occasional tables**
These height-adjustable tables can be used for both standing and sitting with minimal hassle.



Collaborate



↙
54 **Recreation lounge**
The perfect place to enjoy a quick snack and recharge your batteries, both metaphorically and literally as USB charging points are available.

→
55 **Team space**
This well-designed team space provides a high-quality environment for your employees.

↓
56 **Reading bench**
The ideal spot to sit down and read through the latest inspiring magazines.

↓
57 **Inspirational library**
Customize exactly how you want your library space to look – visit usm.com to configure your space.

56



57



58 Living walls

Freestanding shelving is playfully designed with semi-transparent perforated panels in different heights and depths. The Haller E lighting with plants can be combined to create a natural living wall.



Collaborate



↙
59 **Ready to serve**
This is possibly the most compact coffee cart in the market; small enough to fit anywhere!

→
60 **Snack bar**
This green USM Haller unit is accessible from both sides. It provides both storage and a countertop which makes it the perfect office kitchen solution. Additional drawers, doors, dividing shelves and smart accessories can also be added.

↓
61 **Coffee station**
This compact shelving system can hold everything you need and can be reconfigured to suit your needs.

↓
62 **Snack counter**
This counter can present selections of snacks in glass showcases and at the same time create an attractive standing bar for people to gather around.

61



62



63 Adaptable wall shelving

This highly flexible system can be used in conjunction with doors, create additional storage in corridors and work well with slanted ceilings, thanks to its variety of dimensions. In that way, USM turns every nook into a valuable space.



Organize

Organize



↙
64 Wall shelving with media outlet
 USM provides an elegant frame for a flatscreen making everything flush with the wall.

→
65 Inspirational
 Gain inspiration with angled shelving that not only displays magazines but provides valuable storage behind them as well.

↓
66 Freestanding
 A study area can be integrated into a bookshelf.

↓
67 Playfulness
 Colorful accents turn this shelf with integrated work surface into a three-dimensional work of art.

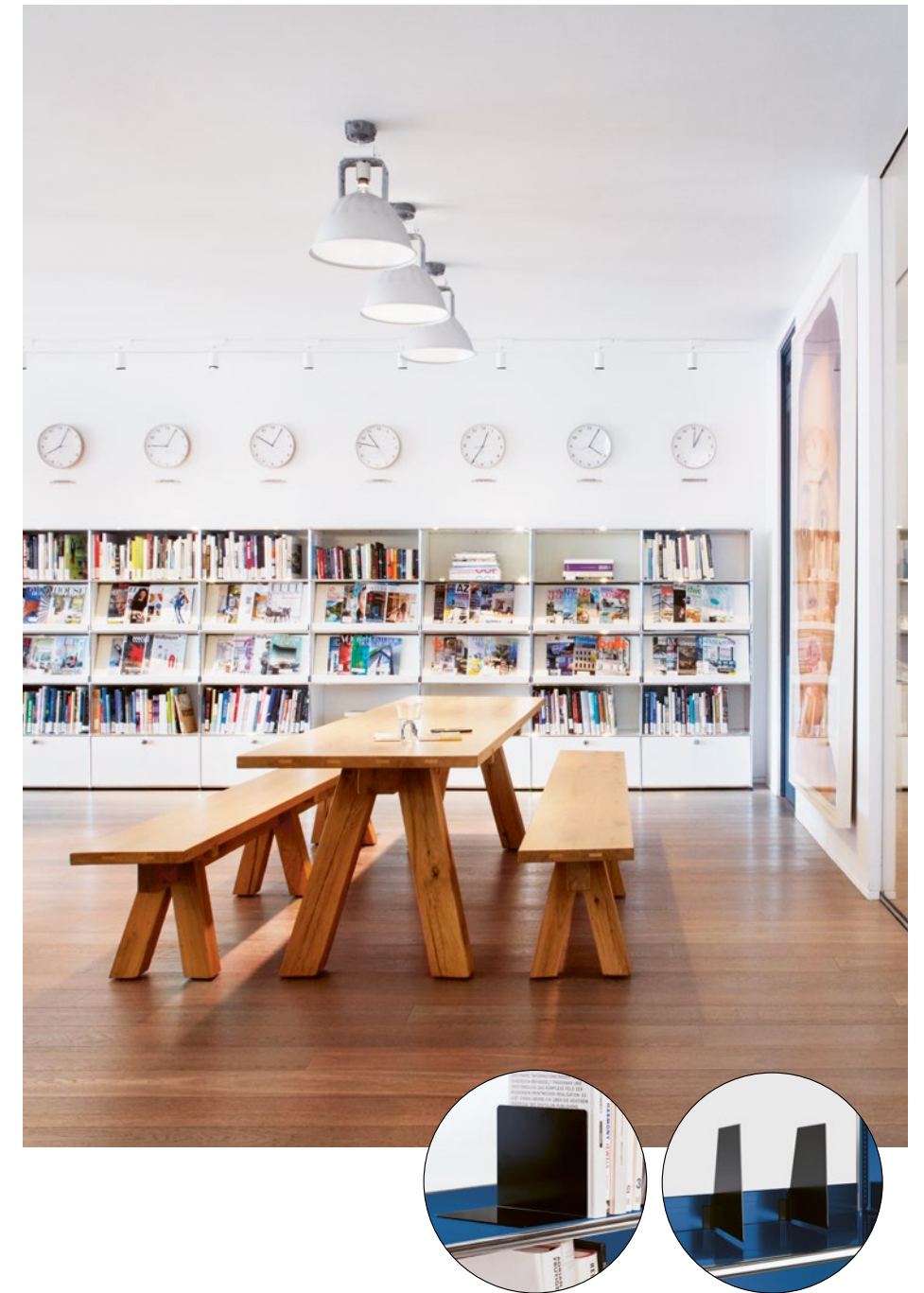

Added storage value
 Magnetic or sliding metal bookends make a perfect match for a USM Haller bookshelf. Discover the full range of smart accessories on page 77.

66



67



Organize

Add value to your storage – love your plants!

Vibrant colors and lush green healthy plants encourage happiness. We firmly believe that green spaces are the best place to work, live and be together. With USM's World of Plants greenery can be easily integrated. The addition of foliage creates eye-catching storage.



→
68 World of plants
Add value to your storage space by integrating lush greenery with the specially-designed planters with water indicator for USM Haller.

↓
69 Dividing space, connecting people
World of Plants is ideal for zoning areas in an open plan office space or dividing different team spaces without the need for any rigid walls.



69

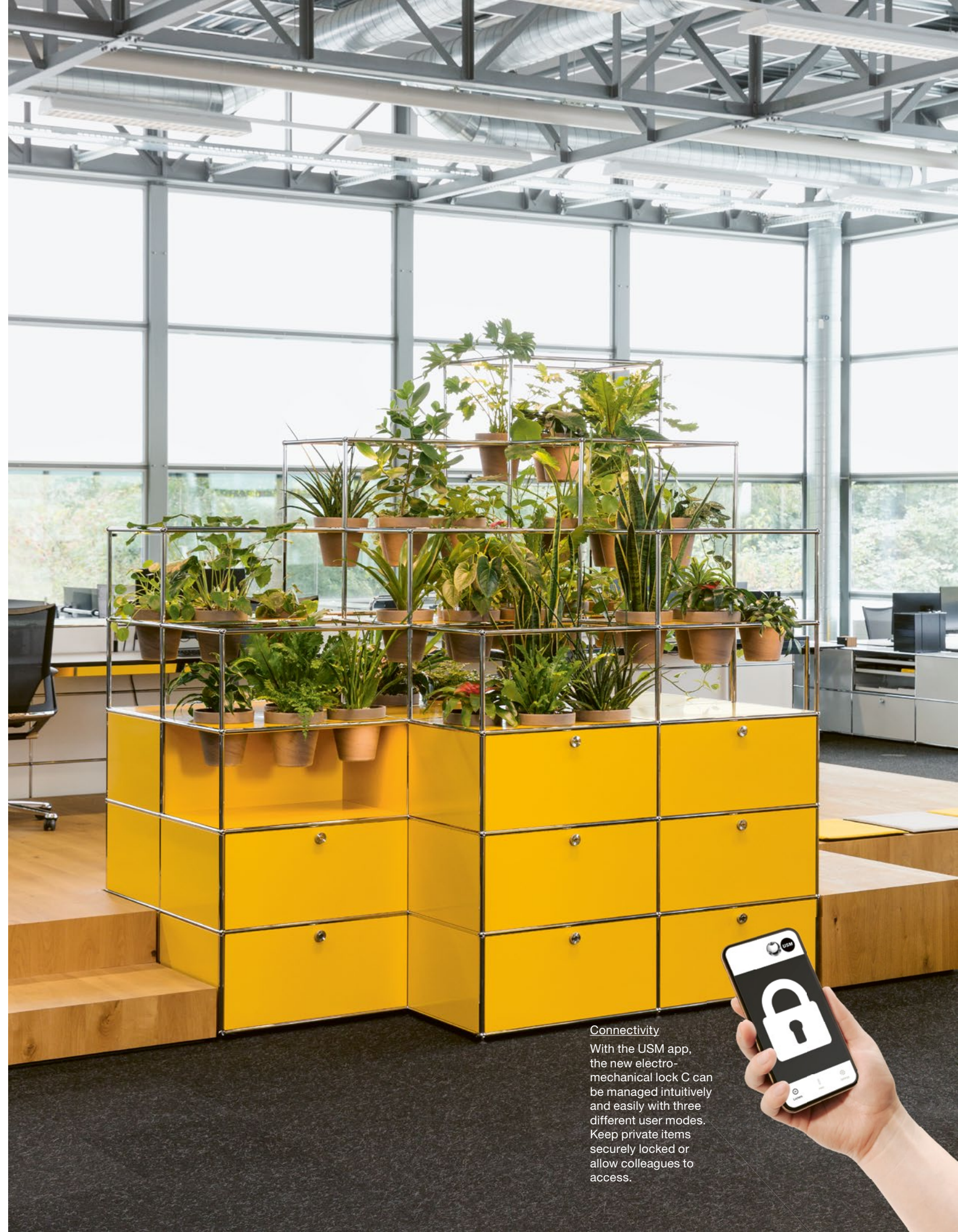

Connectivity

With the USM app, the new electro-mechanical lock C can be managed intuitively and easily with three different user modes. Keep private items securely locked or allow colleagues to access.



Organize

↙
70 **Lockers**
Every employee deserves their own storage space – an impressive wall shelving solution.

↓
71 **Central storage**
The new electromechanical lock C can also be used for extension doors.

↓
72 **Mobile storage**
This system is available on castors so that teams will always have their personal belongings within reach.



Organize

73 Technology centre –
a welcoming hub
This specially designed unit can
be used to house technology
such as printers and servers
as well as providing shared
storage and meeting space
for employees.



What's unique about USM

Building future-proof possibilities:

Our core values run deep and permeate every element of what we do – from building furniture to building relationships.



Timeless Aesthetic

Invented by architect and industrial visionary Fritz Haller at the beginning of the nineteen sixties, the USM Haller System is characterised by a globally recognized, timeless design that compliments buildings' architecture.



Evolving Design

USM furniture isn't static; it can be reconfigured to follow the evolution of users' needs, even after many years. Whether there are changes in use or size, new components will always be compatible with older USM Haller system products.



Strength and Durability

Produced with the same high quality since its invention almost 60 years ago the USM Haller system relies on a unique structural system composed of chromed tubes joined by connecting balls and thermo-lacquered panels, resulting in remarkable durability and timeless style.



Adaptation and Innovation

Thanks to its great ease of installation/dismantling, USM furniture is capable of forever adapting itself to the rapid evolution of technical equipment. Retrofittable at any time.



Low Cost of Use

The outstanding durability and adaptability of USM, as well as the possibility of endlessly reconfiguring furniture regardless of initial function, guarantee a reduced cost of use over time.



Coherence of furniture

Thanks to its unique modular design, the USM system can meet all furniture needs.

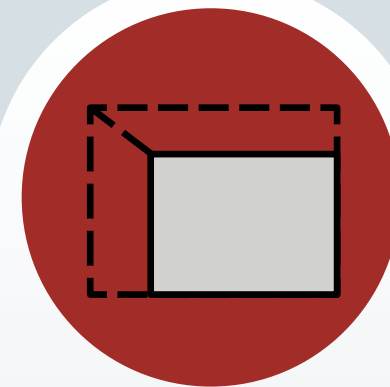

Small Footprint

The strong, sleek and compact structures, achieved by an exemplary quality of construction and choice of materials, allow USM to demonstrate a great conservation of precious space.



Sustainable Development and HQE Standards

USM was the first company in Europe to receive the Greenguard international certification by creating furniture that is coherent with the environmental initiatives of buildings. In 2018, USM Haller and USM Kitos M achieved Cradle to Cradle® certification.

Why USM Haller?

- limitless individualisation
- reconfiguration at any time
- simple integration of plants
- optimisation of acoustics
- retrofitting
- a renowned design classic



Redesign at any time
Our key to modularity lies in the patented ball-and-tube connection.

Various color options
15 standard colors support your individual designs.



World of plants for a healthy climate
Plants improve the indoor climate and thus our working environment. With the world of plants for USM Haller, lively evergreen landscapes can now be easily integrated into the structure of USM Haller.

Smart accessories
Micro organization: smart accessories complement the design classic. Inos drawer sets are now available in all 15 standard colors.



Better acoustics, better atmosphere, less stress

Room acoustics play a decisive role in determining how we feel in our built environment, whether we find the atmosphere pleasant and soothing or stressful and distracting. Where there is less noise, there is less stress and more concentration.



Lock securely, share easily
With the new electromechanical lock C and the specially developed USM app, storage space and lock management take on a whole new dimension.

Why USM Haller E?

- energy-efficient LED ambient and functional light
- almost invisible light source
- USB charger for mobile devices
- wireless and safe power electricity flow through the furniture's own structure



Sensors ensure that light turns on when compartments such as drop-down doors or drawers are being opened.

Energy-efficient

24 volts (low voltage) to efficiently provide electricity to the energy-saving, long-lasting 2 watt LED bulbs and USB chargers.

Adjustable dimming

The extra-flat transformer is an on-off switch and a dimmer in one. It is located under the piece of furniture.

Two light temperatures

Warm light and cold light – depending on purpose and preference, which can be easily switched at any time.

Modular and future-oriented

Just like everything else about USM Haller, the placement of light sources and chargers is modular – you can turn any desired part of the furniture into a power source. All elements can easily be exchanged. Trained USM sales partners are happy to help you plan or expand your furniture according to your needs.



Seamlessly integrated LED tubes

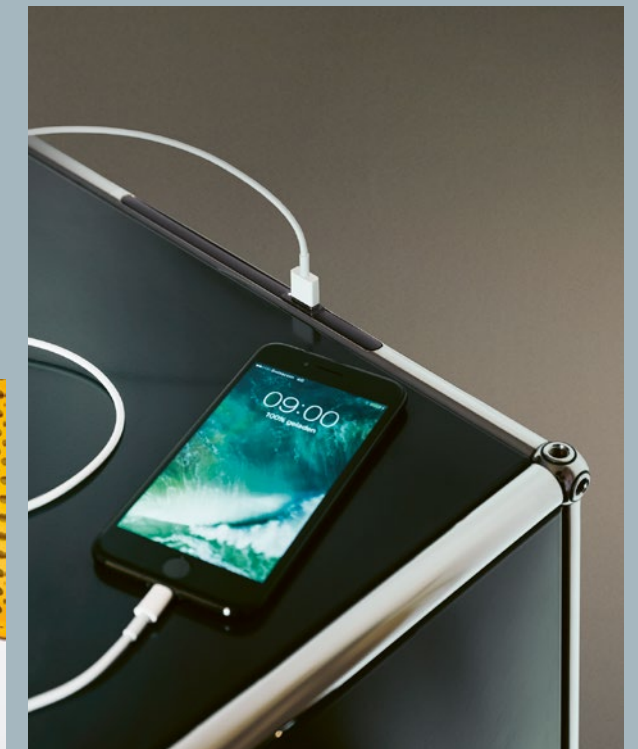

USB charger for charging mobile devices



Why USM Haller table / desks?

- 4 models
- 20 colors and surfaces
- high individualisation with accessories
- easy electrification
- large range of dimensions from 30" to 120"
- perfect size match with USM Haller system

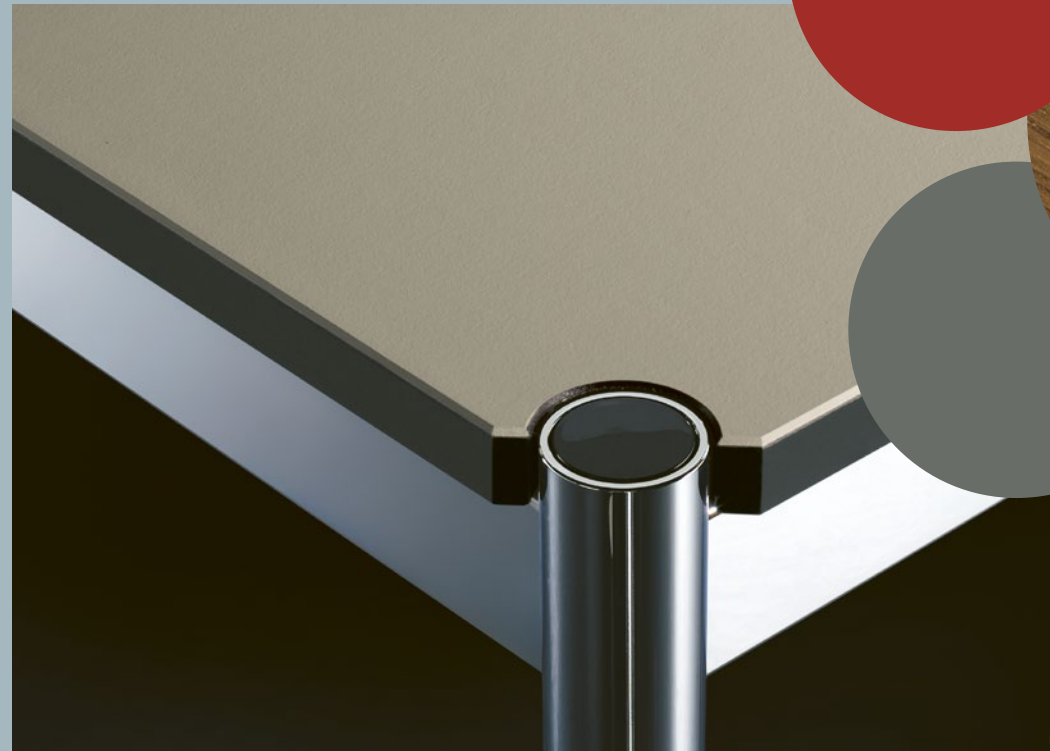

Various design options
A wide range of colors and materials support your customized designs.



USM Haller



USM Haller Plus



USM Haller Advanced



occasional / coffee table

Ergonomic

The patented height adjustment system allows the height of this table to be varied continuously in the range from 27" to 34", to meet individual user requirements. This makes the USM Haller table ideally suited for desk sharing.

Versatile

Useful accessories extend the table's functionality and make room for a wide range of applications. An optional grommet hatch integrated into the tabletop gives easy power and network access.

Smart electrification

Electric cables are neatly stowed away in a cable tray under the tabletop and can easily be accessed via grommet hatches, while tabletop adaptation points allow additional equipment to be easily plugged in.



Height-adjustability



Smart cable and accessory management



Why USM Kitos table / desks?

- 4 models
- 19 colors and surfaces
- high individualisation with accessories
- easy electrification
- immediate mechanical or electric height-adjustment



Various design options
A wide range of colors and materials support your customized designs.



USM Kitos E



USM Kitos E Plus



USM Kitos E Meeting



USM Kitos E free-standing

Ergonomic

The electronic or mechanical height-adjustment system used in the USM Kitos E and USM Kitos M allows for both standing and sitting positions and enables the table to be adapted to the personal requirements of its users. Which makes both models ideally suited for desk sharing and hot desking.

Versatile

The two adaption points in the tabletop allow for easy connection of up to four accessories, making it possible to modify the table to meet individual user requirements.

Smart electrification

All cables can properly be stored in a cable tray mounted underneath the tabletop. Depending on the model, the tabletop can be tilted or pushed backwards for easy access to the cables underneath.

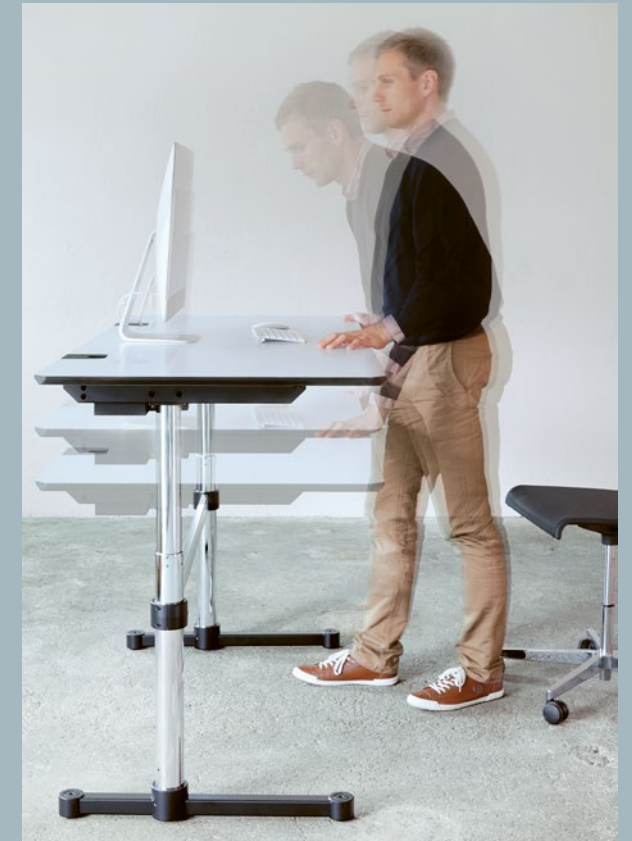

Fast and effortless mechanical height-adjustment.

Intelligent electrification under the movable tabletop; adaption points for USB chargers and other accessories.



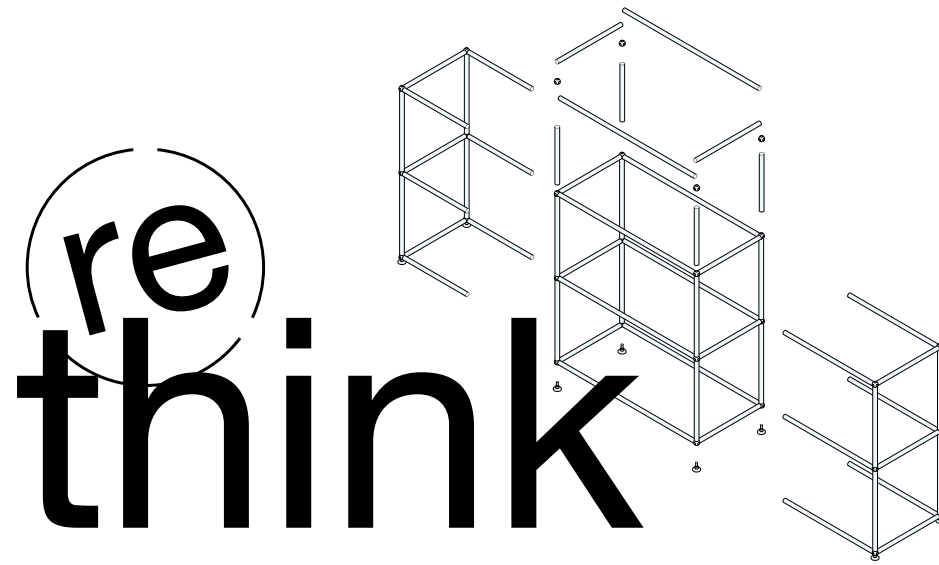

Our vision –
becoming a fully circular business
We want to extend circularity principles beyond our products. That means adopting this philosophy throughout our company – from our product development to our manufacturing, and new business models, from our communications to our supply chain, operations and the expertise of our people.



Our product lines USM Haller and USM Kitos M, accounting for more than 92% of our revenue, carry the Cradle-to-Cradle® certification. It is the leading multi-attribute standard used globally across industries for designing and making products that enable a healthy, fair and sustainable future according to the world's most advanced science-based measures.

re think

Rethink, redesign, revalue sums up the sustainable benefit of our products.

What and how much do you really need? What purposes should a piece of furniture serve? Experienced consultants and virtual planning tools enable us to support you to create a bespoke and conscious purchase. So that you get exactly what you really need, tailored to your current requirements. But don't worry, once furniture has been designed, it can always be rethought and adapted to new circumstances.

Each piece is unique, planned and assembled especially for you. Our furniture is designed to be forever reconfigured. Thanks to the high-quality finish and clever design, all components can be change and extended at any time without any problems. This leads to limitless creative freedom, more individuality in design and almost infinite cycles of use.

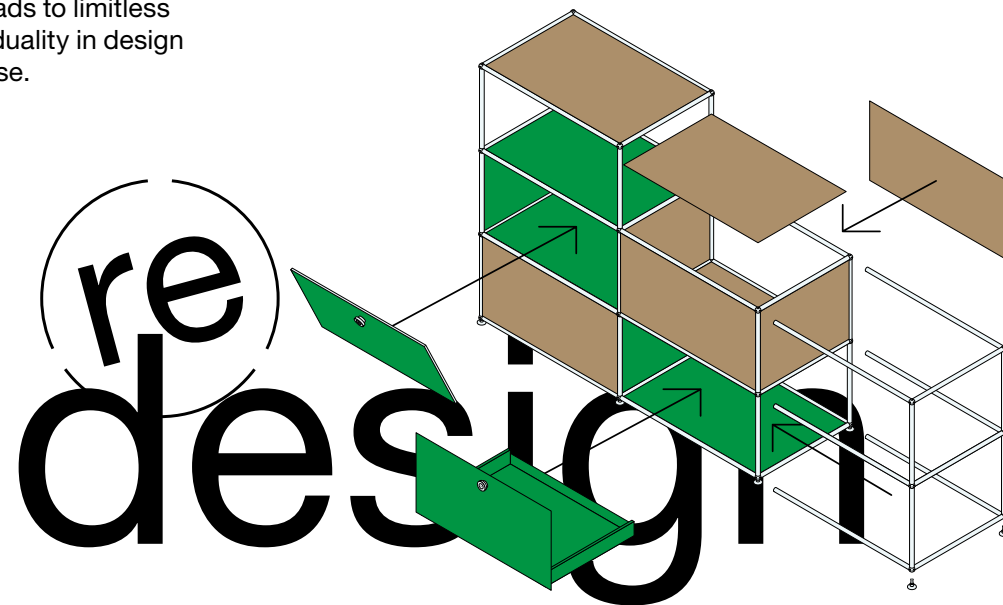

re design

re value

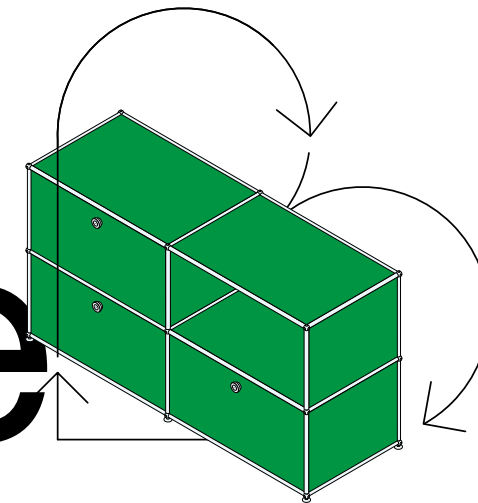

Thanks to the high quality, colours that never fade and a 100% modular system, decades-old USM furniture can be seamlessly combined and upgraded with new components. We believe a product that adapts to your style, your life, your changing needs is relevant and loved.

USM furniture is a valuable companion for life, across generations.



All our four main product lines carry the UL GreenGuard Certification for low chemical emission. Having undergone rigorous scientific testing to meet stringent emissions requirements, this certification approves that our products contribute to a healthier indoor air quality.

With the Science Based Targets initiative (SBTI), carried by several renowned organisations including the United Nations Global Compact and the the Word Wide Fund of Nature (WWF), we have committed to set near-time company-wide emission reductions in line with the latest climate science.

Learn more at
www.usm.com/sustainability



USM Haller

The USM Haller system provides a wide variety of elements in standard sizes. Widths, depths and heights are indicated below. All measurements refer to the distance between axes.

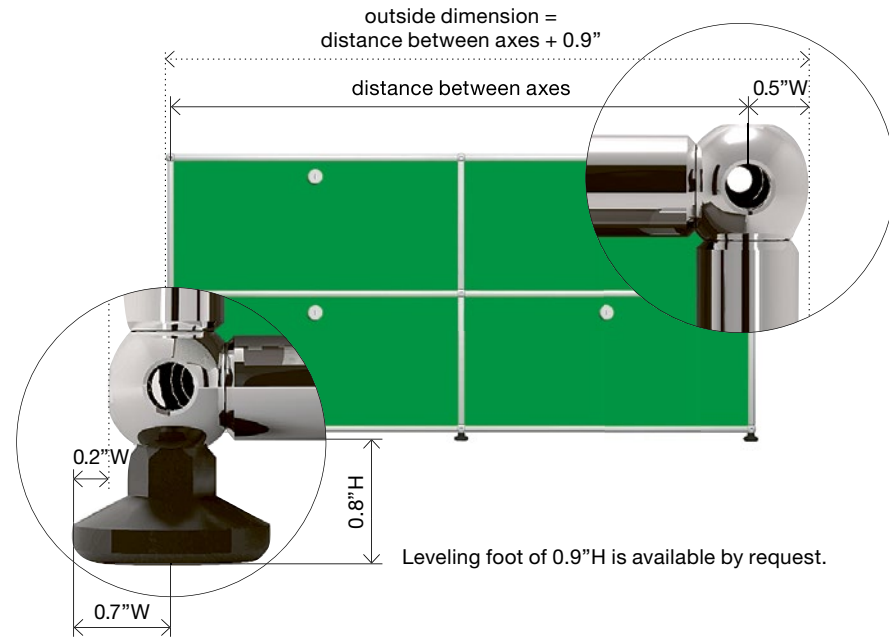

Your safety matters to us. Check out the USM safety instructions now. www.usm.com/safety

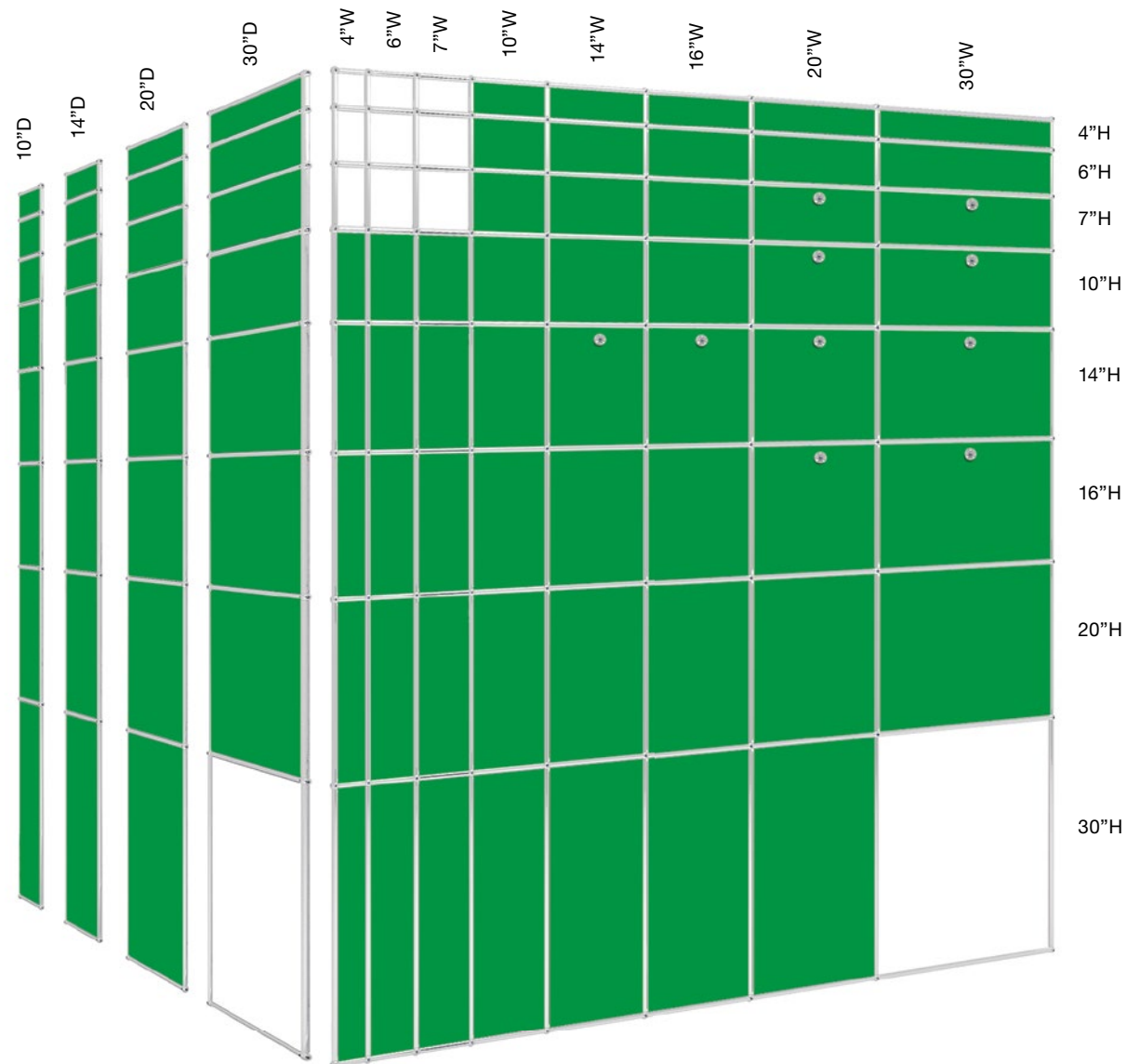

- | Panels | Doors | Shelves and drawers | Accessories |
|--------------------------|---------------------------|--|--|
| 1 Metal panel | 5 Metal flip-up door* | 10 Metal divider shelf | 20 Hanging file baskets |
| 2 Glass panel | 6 Glass door | 11 Glass divider shelf | 21 Metal box insert |
| 3 Acoustic panel | 7 Acoustic drop-down door | 12 Metal extension shelf | 21a Slide profile for metal box insert |
| 4 Perforated metal panel | 8 Metal drop-down door | 13 Metal angled shelf | 22 Cable cut-out |
| | 9 Metal extension door* | 14 Extension filing set with extension shelf | 23 Metal magnetic bookend |
| | | 15 Drawer 4" | 24 USM Inos Felt Box |
| | | 16 Drawer 6" | 25 USM Inos DVD tray |
| | | 17 Drawer 10" | 26 USM Inos CD tray |
| | | 18 Drawer 12" | |
| | | 19 Metal plant panel with circular recesses to hold the pots | |
| | | | 27 USM Inos angled file trays |
| | | | 28 Bookend |
| | | | 29 USM Inos box set, open |
| | | | 30 USM Inos box set, closed |
| | | | 31 USM Inos organizing drawer set |



*Acoustic version available.

Illustration: USM Haller in 20\"/>

USM Haller E

A modular structure of your design, either completely or partially equipped with e-Balls and e-Tubes, is connected to a source of electricity. The structure itself conducts the low voltage electricity to the desired location using the e-Balls, e-Connectors and e-Tubes to form a circuit. USB chargers or light sources can be snapped into place in pre-cut recesses. The power supply is drawn from any point near the ground. The power supply cable is attached to an e-Ball, and the power adapter is subsequently tucked underneath the furniture until only the operating switch remains visible. From this point the power supply requires no further cables but rather is integrated into the structure of the furniture.

Application options

- 1 **Glass panel**
Glass elements can be illuminated throughout.
- 2 **Without metal paneling**
Compartments without metal paneling can be completely illuminated.
- 3 **With metal paneling**
Compartments with metal paneling can be illuminated from the front.
- 4 **Compartment with an extension shelf**
The entire compartment with an extension shelf can be illuminated.
- 5 **Drop-down and extension door**
Via the "Light When Compartment Is Open" function, the light automatically turns on when the door is opened.
- 6 **Angled shelf**
The presentation space is illuminated from the front.
- 7 **Floor lighting**
With floor lighting, the light shines at a 25-degree angle under the furniture.
- 8 **Ambient lighting**
The light is directed vertically towards the back, illuminating the surroundings with a warm glow.
- 9 **e-USB charger**
It can be integrated in the same places as the e-Lights.

e-Elements

- 1 **e-Lights**
Dimmable, available in
– Warm white 2700 Kelvin
– Cold white 5700 Kelvin
Both with or without the "light at compartment opening" function.
- 2 **e-USB charger**
Provides a voltage of 5 volts to the connected device. (Capacity: 6.5 W)
- 3 **e-Dummy**
Sleek, black e-Dummy element, closes recesses that are unutilised. Can be changed for additional e-Lights or e-USB charger later.
- 4 **e-Tube (power outlet)**
Tubes with recesses for e-Lights, e-USB chargers or e-Dummy elements that can be easily snapped into place or replaced.

14"D, 1 recess
20"D, 2 recesses
30"D, 3 recesses
- 5 **e-Tube (conductive)**
The conductive e-Tube serves to conduct the electricity if no inserts are desired in this location. It is available in lengths of 30", 20", 16", 14", 10" and 7".
- 6 **e-Ball, e-Connector**
To enable the flow of electricity, the ball and connector were refined. The exterior dimensions remain unchanged. The distinguishing feature of the ball is the black insulation ring.
- 7 **e-Power supply**
Includes dimmer at the operating switch. Transforms the power supply voltage to 24 volts. (Capacity: 60 W)

CE

Engineered & Made in Switzerland.



Winner of the German Design Award 2019 for outstanding design quality in the Office Furniture category



Winner of the Wallpaper Design Awards 2018



Winner of the Focus Gold Award 2018 for outstanding design quality



Winner of the Muuz International Award 2018 in the furniture category





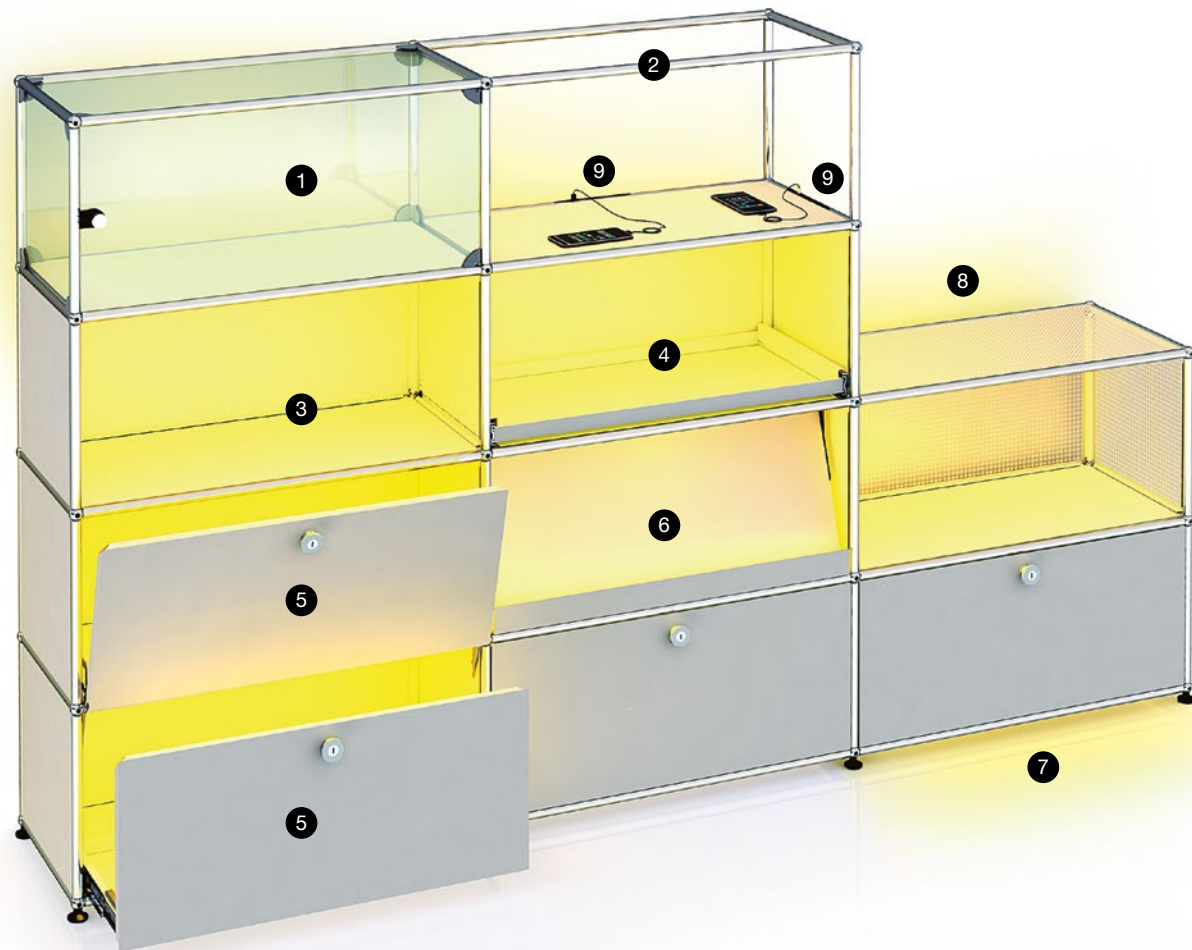

Winner of the FX Design Awards, Lighting Product 2017



USM Haller table / desk

Designed almost 60 years ago, the USM Haller table still embodies timeless elegance. Its clean lines perfectly harmonize with the modular furniture system of the same name.

Classic table	Sliding tabletop + adaptation points	Working desk	Occasional / coffee table
Optional cable basket underneath the tabletop	Integrated cable tray accessible from above by sliding back the tabletop Adaptation points for accessories	Optional cable basket underneath the tabletop Removable adaptation points for accessories	
			
USM Haller	USM Haller Advanced	USM Haller Plus	USM Haller occasional / coffee table
29"H 120"W/39"D 120"W/30"D 98"W/39"D 98"W/30"D 89"W/39"D 89"W/30"D 39"W/39"D 30"W/30"D 59"W/20"D** 49"W/20"D**	29"H or 27"-34"H* 79"W/39"D 79"W/30"D 69"W/39"D 69"W/30"D 59"W/39"D 59"W/30"D 49"W/30"D	29"H 120"W/39"D 120"W/30"D	15"H 120"W/39"D 120"W/30"D 98"W/39"D 98"W/30"D 89"W/39"D 89"W/30"D 79"W/39"D 79"W/30"D 69"W/39"D 69"W/30"D 59"W/39"D 49"W/30"D 39"W/39"D 30"W/30"D
	29"H or 27"-34"H* 79"W/39"D 79"W/30"D 69"W/39"D 69"W/30"D 59"W/39"D 59"W/30"D 49"W/30"D	29"H or 27"-34"H* 79"W/39"D 79"W/30"D 69"W/39"D 69"W/30"D 59"W/39"D 59"W/30"D 49"W/30"D	

Accessories for all USM Haller table / desk

- Grommet hatch for network access**
Flush hinged cover set into the tabletop for easy network access, can be positioned right or left.
- Cable management**
For the Advanced table type, a cable tray integrated under the tabletop offers storage room and attachment options for all cables and technical components. For the traditional USM Haller Table and the USM Haller Plus, a cable basket can be attached.
- CPU holder**
Computers in various sizes can be mounted using a simple holding device under the table.
- Link chain**
Holds and directs cables to the power source. Flexible and adjustable to various lengths.
- Flat screen pivot arm**
Screens are screwed to the height adjustable pivot arm using a mounting plate (VESA standard). Available for USM Haller classic desk: The pivot arm can be mounted onto the table edges with the universal holder or into the table leg using an assembly tube. Available for USM Haller Plus and Advanced: The bracket can be connected directly to one of the adaptation points.
- Front and side panel**
A black mesh fabric can be attached to the back or the side under the table frame. Available for the following table sizes: 79"W, 69"W, 59"W, 49"W, 39"W, 30"W and depths: 39"D, 30"D.
- Material tray**
Provides room for writing instruments and can be discreetly stowed under the tabletop.
- USM Privacy Panels**
Fitted on the long side of the table to provide individualisation and privacy. 14"H or 28"H. Available for the following table sizes: 120"W, 98"W, 89"W, 79"W, 69"W, 59"W, 49"W*
- Flat screen support bar**
The bracket is inserted into the adaptation points. Up to two screens (max. 2 x 26 pounds) can be attached using a mounting plate (VESA standard). Screens can be mounted at different heights; screens can be adjusted with ball joints.
- USB adapter**
The adapter can be used for USB A 3.0 and C connections. It can easily be inserted into the adaptation point. Usable as power supply or for data transfer.
- Lamp peg**
An optional lamp peg for easy attachment of traditional table lamps. Electrification is possible through the adaptation point.

Cable duct
The classic USM Haller table can be updated with a black aluminum cable duct section, with lids that fold open on both sides, to integrate cables. This enables the table depths to be expanded to the EU standard of more than 32". Available for the following table sizes: of 79"W, 69"W, 59"W, 49"W, 39"W, 35"W, 30"W.

Accessories for USM Haller Plus / Advanced desk

- Flat screen support bar**
The bracket is inserted into the adaptation points. Up to two screens (max. 2 x 26 pounds) can be attached using a mounting plate (VESA standard). Screens can be mounted at different heights; screens can be adjusted with ball joints.
- Options**
- Flat screen support bar fix**
- Flat screen support bar adjustable**
Move forwards or backwards two notches at a time to adjust the viewing distance.

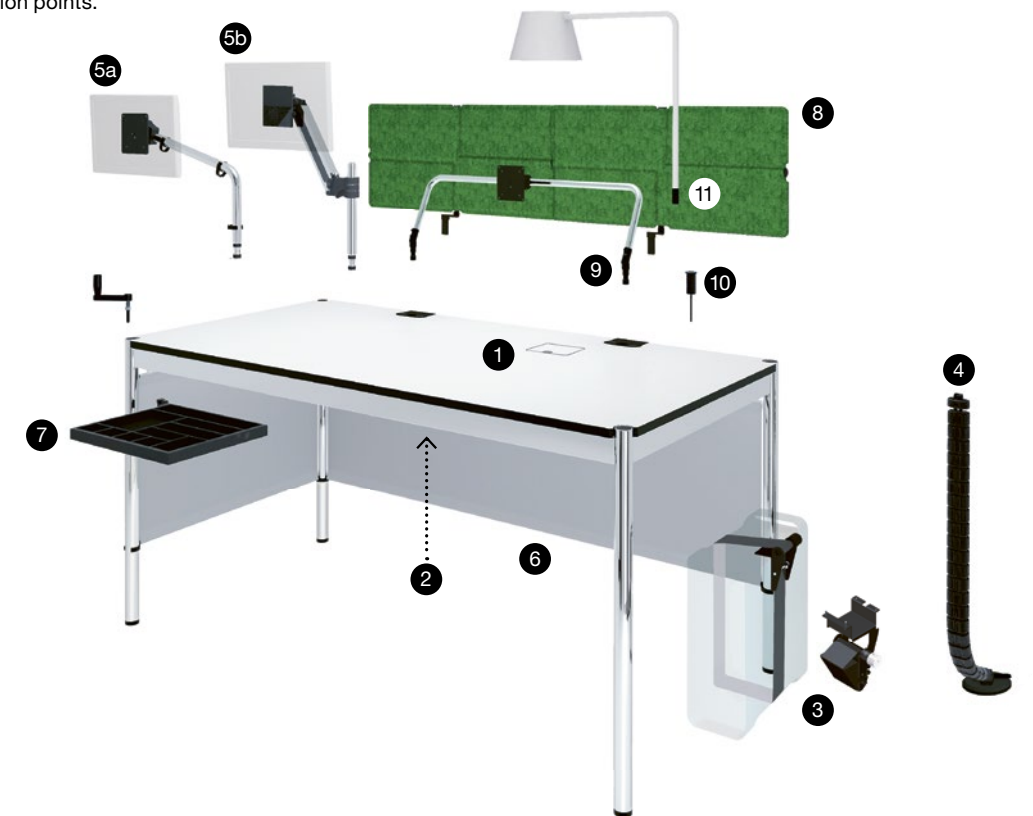

* Manual height adjustment with a removable handle.
** Note: These sizes are not yet included in the standard range.

USM Kitos M and E table / desk

Each desk of the USM Kitos M and E family offers integrated smart solutions for electrification, excluding free-standing.

Why USM Kitos M?

The "M" in its name stands for mechanical spring-loaded height adjustment; adjustment time approx. 1 sec. with zero energy consumption. This system is more than 10 times faster than the electronic equivalent and has an extremely long operating life.

Why USM Kitos E?

Maximum functionality and captivating design – USM Kitos E unites all requirements in one modern workplace: continuous height adjustability and maximum stability. A distinction is made between fixed and motor-driven legs in the E1, E2 and E3 models.

E1



29"H
With or without middle traverse

E2 with 1 motor



28"–47"H
Adjustment time approx. 30 sec.
With middle traverse

E3 with 2 motors



26"–51"H
Adjustment time approx. 20 sec.
With middle traverse

Basic desk

Integrated cable tray underneath the tabletop



USM Kitos M

28"–47"H
70"W/35"D
69"W/30"D
63"W/32"D

Sliding tabletop

Integrated cable tray accessible from above by sliding back the tabletop
Adaptation points for accessories



USM Kitos M Plus

28"–47"H
70"W/35"D
69"W/30"D
63"W/32"D

Extra size

Integrated cable tray underneath the tabletop and accessible from all sides



USM Kitos M Meeting

28"–45"H
99"W/40"D
89"W/40"D

Side table



USM Kitos E Free-standing

29"H or 28"–43"H
Square
30"W/30"D or 35"W/35"D
Round
Ø: 35" or 43"

USM Kitos E

70"W/35"D**
69"W/30"D
63"W/32"D**
Available with E1*, E2 or E3** columns

USM Kitos E Plus

70"W/35"D
69"W/30"D
63"W/32"D
Available with E1*, E2 or E3 columns

USM Kitos E Meeting

99"W/50"D
99"W/40"D
89"W/40"D
Available with E1, E2 or E3 columns

The table can also be provided with an asymmetrical version of the middle traverse, for extra legroom. (This is not possible with the USM Kitos E / M Meeting.)

* Available with or without middle traverse.

** Available in a GS-Mark tested version with 0.12" table edge radius and the asymmetrical middle traverse.

Accessories for all USM Kitos M and E table / desk

- Grommet hatch for network access**
Flush hinged cover set into the tabletop for easy network access, can be positioned at two different locations.
- CPU holder**
Computers in various sizes can either be mounted using a simple holding device under the height-adjustable tabletop or attached to the table column.
- Link chain**
Holds and directs cables to the power source. Flexible and adjustable to various lengths.
- USM Privacy Panels**
Fitted on the long side of the table to provide individualisation and privacy. 14"H or 28"H. Available for the following table sizes: 99"W, 89"W, 70"W, 69"W, 63"W.

Accessories for all USM Kitos M and E table / desk, except USM Kitos M Meeting / E Meeting

- Flat screen pivot arm**
Screens are screwed to the height adjustable pivot arm using a mounting plate (VESA standard). Available for USM Kitos E/M desk: The pivot arm can be mounted onto the table edges with the universal holder. Available for USM Kitos M and E Plus: The bracket can be connected directly to one of the adaptation points.
- Options**
 - Mounting at different heights**
is possible for screens weighing up to 26 pounds.
 - Continuous height adjustment**
for screens weighing up to 26 pounds.
- Front panel**
A black mesh fabric attaches to the front under the tabletop. Available for the following table sizes: 70"W, 69"W, 63"W.
- Material tray**
Provides room for writing instruments and can be discreetly stowed under the tabletop.

Accessories for USM Kitos M Plus / E Plus

- Flat screen support bar**
The bracket is inserted into the adaptation points. Up to two screens (max. 2 x 26 pounds) can be attached using a mounting plate (VESA standard). Screens can be mounted at different heights; screens can be adjusted with ball joints.
 - Flat screen support bar fix**
 - Flat screen support bar adjustable**
Move forwards or backwards 2 notches at a time to adjust the viewing distance.
- USB adapter**
The adapter can be used for USB A 3.0 and C connections. It can easily be inserted into the adaptation point. Usable as power supply or for data transfer.
- Lamp peg**
An optional lamp peg for easy attachment of traditional table lamps. Electrification is possible through the adaptation point.

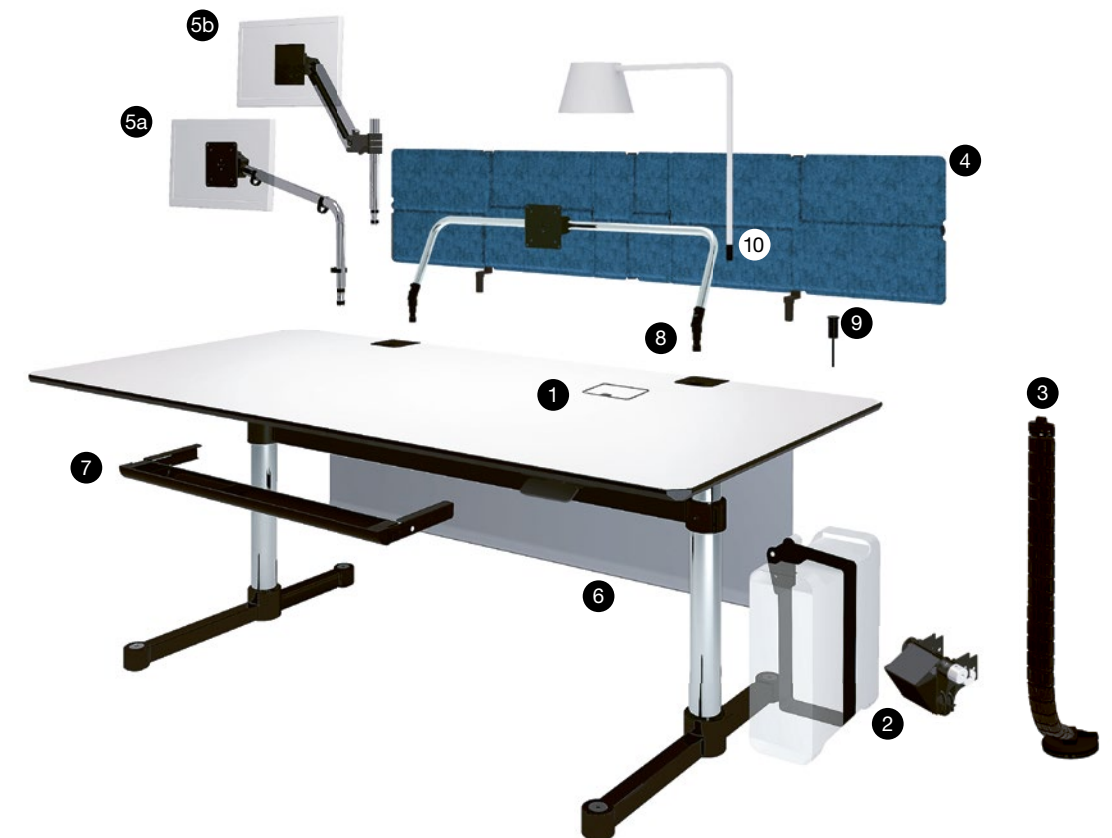

USM Kitos table / desk

Available at a fixed height, with incremental or free-flow height adjustment, which can be adjusted electronically.



USM Kitos Rectangular

29"H
70"W/35"D
69"W/30"D
59"W/30"D
35"W/30"D

Stepwise height adjustment
27"-31"H / 42"H
70"W/35"D
69"W/30"D
59"W/30"D
35"W/30"D

Continuous height adjustment
28"-47"H*
70"W/35"D
69"W/30"D
59"W/30"D
35"W/30"D

USM Kitos Free-standing

29"H
Square
35"W, 30"W
Round
Ø 43", 35"

Stepwise height adjustment
27"-31"H / 42"H
Square
30"W
Round
Ø: 35"
Rectangular
35"W/30"D

Continuous height adjustment
H: 27"-43"H*
Square
30"W
Round
Ø: 35"

Accessories for all USM Kitos classic table / desk

- 1 **Universal support**
Mounts to the table support or directly to the tabletop to hold various accessories.
- 2 **Flat screen pivot arm**
Screens are screwed to the height-adjustable pivot arm using a mounting plate (VESA standard). This can be mounted onto the tabletop using the universal support (1).
- 3 **Cable duct**
Black aluminum profile to accommodate power strips (6) and cables. With a hinged cover on both sides.
Available for the following table lengths: 70"W, 69"W, 59"W, 35"W.
- 4 **USM Privacy Panels**
Fitted on the long side of the table to provide individualisation and privacy.
14"H or 28"H.
Available for the following table sizes: 70"W, 69"W, 59"W.
- 5 **Link chain**
Holds and directs cables to the power source. Flexible and adjustable to various lengths.
- 6 **CPU holder**
Mounts to the table supports. Height-adjustable and rotating. An adjustable strap ensures a secure fit for most standard CPUs.
- 7 **Cable wire basket**
Mounts to the underside of the work surface.
- 8 **Material tray**
Mounts and pivots out from under the table surface.



*Not available in glass.

Colors & surfaces

USM Haller



Metal



Pure white
RAL 9010



Light gray
RAL 7035



USM matte silver



USM mid-gray



Anthracite
RAL 7016

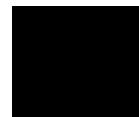

Graphite black
RAL 9011



Steel blue
RAL 5011



Gentian blue
RAL 5010



USM green



Golden yellow
RAL 1004



Pure orange
RAL 2004



USM ruby red



USM brown



USM beige



Olive green
RAL 6003

USM Haller and USM Kitos tables / desks



Powder-coated MDF



Pure white
RAL 9010

Trans-parent glass



Transparent
glass

Linoleum

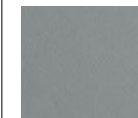

Ash linoleum



Charcoal
linoleum



Black linoleum

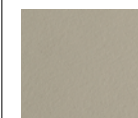

Pebble linoleum



Mauve linoleum

Laminate



Pearl gray
laminate



Pastel gray
laminate



Light mid-gray
laminate



Dark warm gray
laminate

Fenix



Fenix,
Bianco Kos



Fenix,
Grigio Londra



Fenix,
Nero Ingo

Oiled or lacquered veneer

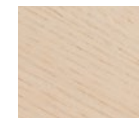

White oiled
oak veneer

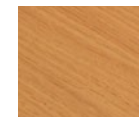

Natural oiled
oak veneer

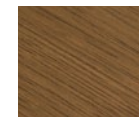

Brown oiled
oak veneer



Natural lacquered
oak veneer



Natural lacquered
beech veneer

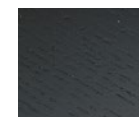

Black lacquered
oak veneer

The tabletops in glass are only available for USM Haller desks up to 79"W and all USM Kitos desks with a fixed height (29"W) or stepwise height adjustment and continuous height adjustment (27"-31"H / 42"H).

Other colors and surfaces available upon request.

Prices and delivery times of table surfaces upon request.

USM Privacy Panels



Fabric panel



Light gray

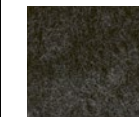

Anthracite



Blue



Green

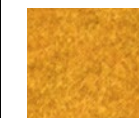

Yellow

USM Inos box



Fabric panel



Light gray

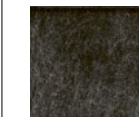

Anthracite

USM Inos drawer set



Metal



Pure white
RAL 9010



USM matte silver



Anthracite
RAL 7016



Steel blue
RAL 5011



USM green



Pure orange
RAL 2004



USM brown



Olive green
RAL 6003



Light gray
RAL 7035



USM mid-gray



Graphite black
RAL 9011



Gentian blue
RAL 5010



Golden yellow
RAL 1004



USM ruby red



USM beige

The following options are available in graphite black and pure white only: USM Inos drawer set, 5 drawers, open USM Inos drawer set, 10 drawers, closed USM Inos drawer set, 10 drawers, open

Planters



Clay

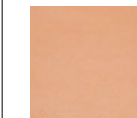

Terracotta

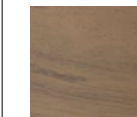

Basalt

Details

USM Haller

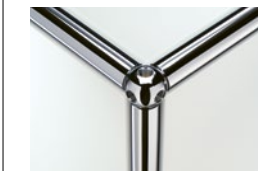

Metal

USM Haller table

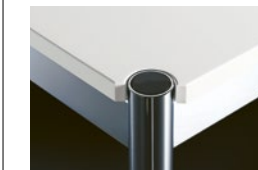

Powder-coated MDF

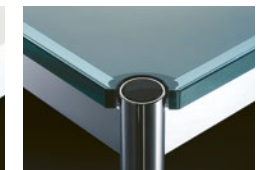

Transparent glass



Linoleum

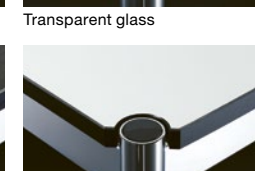

Laminate

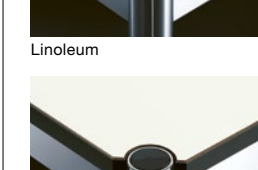

Fenix

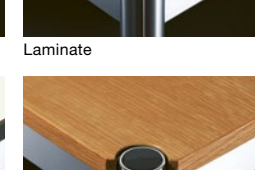

Oiled or lacquered veneer

USM Kitos table



Powder-coated MDF

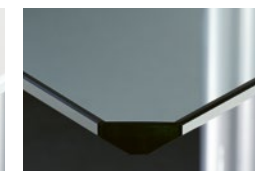

Transparent glass



Linoleum

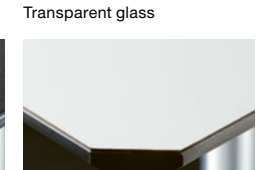

Laminate

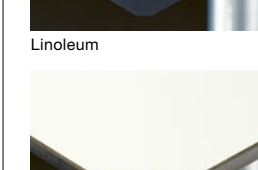

Fenix

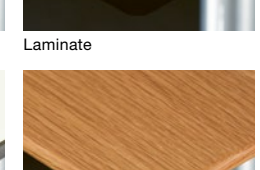

Oiled or lacquered veneer



06.2024, us, 1000



Switzerland

USM U. Schärer Söhne AG
Thunstrasse 55, 3110 Münsingen
Phone +41 31 720 72 72, info.ch@usm.com

Germany

USM U. Schärer Söhne GmbH
Siemensstraße 4a, 77815 Bühl
Phone +49 7223 80 94 0, info.de@usm.com

France

USM U. Schärer Fils SA, Showroom
23, rue de Bourgogne, 75007 Paris
Phone +33 1 53 59 30 37, info.fr@usm.com

United Kingdom

USM U. Schaerer Sons Ltd., London Showroom
Ground Floor, 49–51 Central St., London, EC1V 8AB
Phone +44 207 183 3470, info.uk@usm.com

USA

USM U. Schaerer Sons Inc., New York Showroom
28–30 Greene Street, New York, NY 10013
Phone +1 212 371 1230, info.us@usm.com

Japan

USM U. Schaerer Sons K.K., Tokyo Showroom
Marunouchi MY PLAZA 1 · 2F
2-1-1 Marunouchi, Chiyoda-ku, Tokyo 100-0005
Phone +81 3 6635 9420, info.jp@usm.com

All other countries
contact USM Switzerland.

www.usm.com



USM creative at work